

**DALLAS**  
SEMICONDUCTOR

## DS2107A SCSI Terminator

### FEATURES

- Fully compliant with SCSI and SCSI-2 standards
- Backward compatible to the DS2107S
- Provides active termination for 9 signal lines
- Laser-trimmed 110 ohm termination resistors have 1% tolerance
- Low dropout voltage
- Power-down mode isolates termination resistors from the bus
- Handles actively negated SCSI signals
- Onboard thermal shutdown circuitry
- 16-pin plastic SOIC (DS2107AS) and 20-pin plastic thin SSOP (DS2107AE)

### PIN ASSIGNMENT

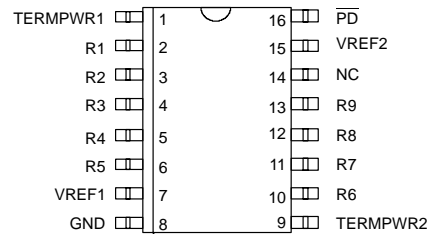

DS2107AS 16-Pin SOIC (300 mil)

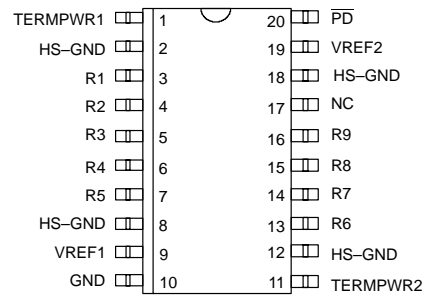

DS2107AE 20-Pin TSSOP (173 mil)

### ACTUAL FOOTPRINT SIZE

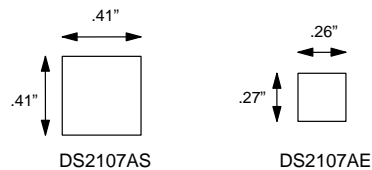

### DESCRIPTION

The SCSI-2 standard recommends the use of active terminations at both ends of every cable segment in a SCSI system with single-ended drivers and receivers. The DS2107A SCSI Terminator, which is fully compliant with the standard, enables the designer to gain the benefits of active termination: greater immunity to voltage drops on the TERMPWR (TERMination PoWeR)

line, enhanced high-level noise immunity, intrinsic TERMPWR decoupling, and very low quiescent current consumption. The DS2107A integrates a regulator and nine precise switched 110 ohm termination resistors into a monolithic IC.

### FUNCTIONAL DESCRIPTION

The DS2107A consists of a bandgap reference, buffer amplifier, and nine termination resistors (Figure 1). The bandgap reference circuit produces a precise 2.55V level which is fed to a buffer amplifier. The buffer produces a 2.85V level and is capable of sourcing at least 24 mA into each of the termination resistors when the signal line is low (active). When the driver for a given signal line turns off, the terminator will pull the signal line to 2.85V (quiescent state). To handle actively negated SCSI signals, the buffer can sink 200 mA. When all lines settle in the quiescent state, the regulator will consume about 5 mA. When the DS2107A is put into power-down mode by bringing  $\overline{\text{PD}}$  low, the power-down circuitry will turn off the transistors on each signal line. This will isolate the DS2107A from the signal lines and effectively remove it from the circuit. The power-down pin ( $\overline{\text{PD}}$ )

has an internal 50K ohm pull-up resistor. To place the DS2107A into an active state, the  $\overline{\text{PD}}$  pin should be left open circuited.

To ensure proper operation, both the TERMPWR1 and TERMPWR2 pins must be connected to the SCSI bus TERMPWR line and both the VREF1 and VREF2 pins must be tied together externally. Each DS2107A requires parallel 0.1  $\mu\text{F}$  and 4.7  $\mu\text{F}$  capacitors connected between the VREF pins and ground. Figure 2 details a typical SCSI bus configuration. In an 8-bit wide SCSI bus arrangement ("A" Cable), two DS2107A's would be needed at each end of the SCSI cable in order to terminate the 18 active signal lines. In a 16-bit wide SCSI bus arrangement ("P" Cable), three DS2107A's would be needed at each end of the SCSI cable in order to terminate the 27 active signal lines.

**DS2107A BLOCK DIAGRAM** Figure 1

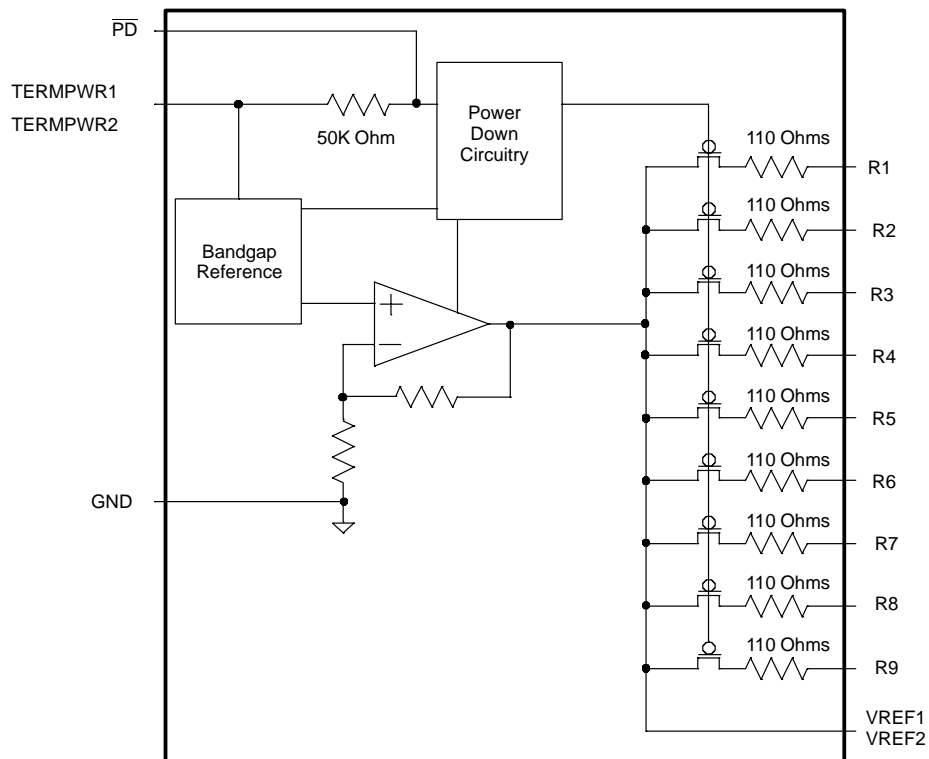

TYPICAL SCSI BUS CONFIGURATION Figure 2

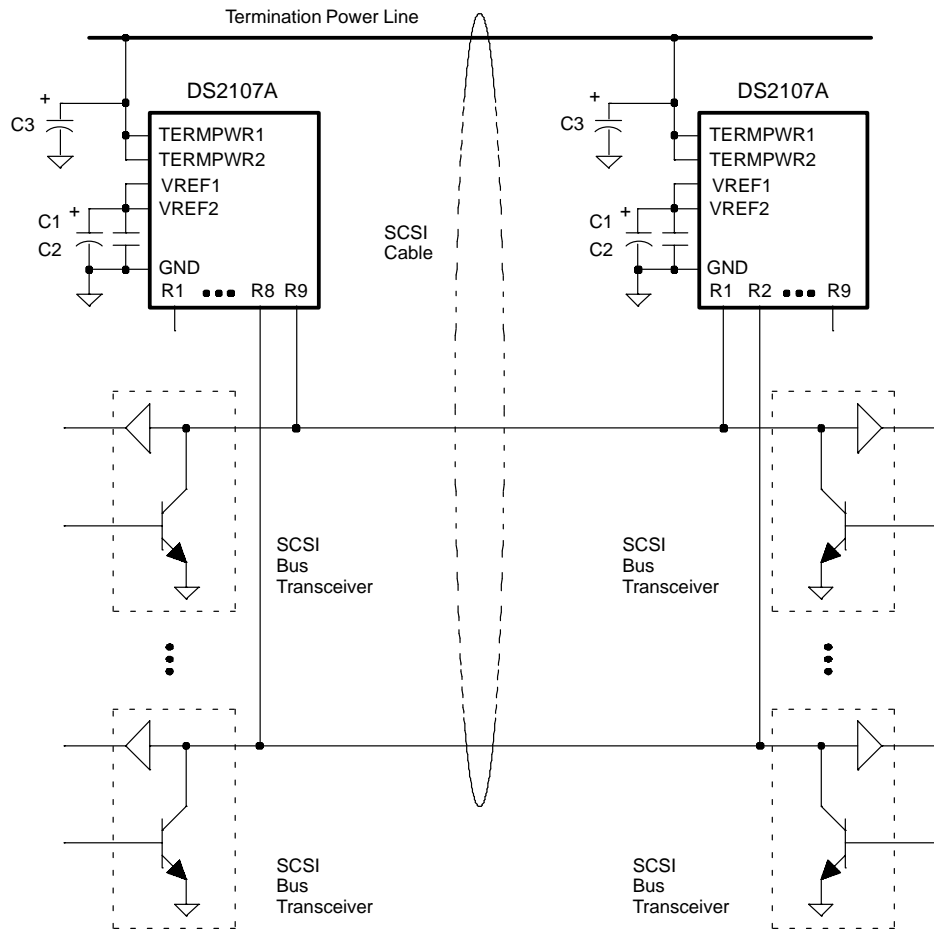
**NOTES:**

1. C1 = 0.1 $\mu$ F ceramic  
C2 = 4.7 $\mu$ F tantalum  
C3 = 2.2  $\mu$ F tantalum or 4.7  $\mu$ F aluminum
2. If the DS2107A is to be embedded into a peripheral that will act as a target on a SCSI bus, it is recommended that TERMPWR be derived from the SCSI cable, not generated locally. In this configuration, if a power failure occurs in the peripheral, it will not affect the bus.

**PIN DESCRIPTION** Table 1

DS2107AE PIN	DS2107AS PIN	SYMBOL	DESCRIPTION
1	1	TERMPWR1	<b>Termination Power 1.</b> Should be connected to the SCSI TERMPWR line. Must be decoupled with either a 2.2 $\mu$ F or 4.7 $\mu$ F. See Figure 2.
3	2	R1	<b>Signal Termination 1.</b> 110 ohm termination.
4	3	R2	<b>Signal Termination 2.</b> 110 ohm termination.
5	4	R3	<b>Signal Termination 3.</b> 110 ohm termination.
6	5	R4	<b>Signal Termination 4.</b> 110 ohm termination.
7	6	R5	<b>Signal Termination 5.</b> 110 ohm termination.
9	7	VREF1	<b>Reference Voltage 1.</b> Must be externally connected directly to the VREF2 pin. Must be decoupled with a 4.7 $\mu$ F and a 0.1 $\mu$ F as shown in Figure 2.
10	8	GND	<b>Ground.</b> Signal ground; 0.0V.
11	9	TERMPWR2	<b>Termination Power 2.</b> Should be connected to the SCSI TERMPWR line. Must be decoupled with either a 2.2 $\mu$ F or 4.7 $\mu$ F. See Figure 2.
13	10	R6	<b>Signal Termination 6.</b> 110 ohm termination.
14	11	R7	<b>Signal Termination 7.</b> 110 ohm termination.
15	12	R8	<b>Signal Termination 8.</b> 110 ohm termination.
16	13	R9	<b>Signal Termination 9.</b> 110 ohm termination.
17	14	NC	<b>No Connect.</b> Do not connect any signal to this pin.
19	15	VREF2	<b>Reference Voltage 2.</b> Must be externally connected directly to the VREF1 pin. Must be decoupled with a 4.7 $\mu$ F and a 0.1 $\mu$ F as shown in Figure 2.
20	16	PD	<b>Power Down.</b> When tied low, the DS2107A enters a power-down mode. Contains an internal 50K pull-up. Strap low to deactivate the DS2107A, leave open circuited to activate the DS2107A.
2,8,12,18	N/A	HS-GND	<b>Heat Sink Ground.</b> Internally connected to the mounting pad. Should be either grounded or electrically isolated from other circuitry.

**ABSOLUTE MAXIMUM RATINGS\***

Voltage on Any Pin Relative to Ground	-1.0V to +7.0V
Operating Temperature	0°C to +70°C
Storage Temperature	-55°C to 125°C
Soldering Temperature	260°C for 10 seconds

\* This is a stress rating only and functional operation of the device at these or any other conditions above those indicated in the operation sections of this specification is not implied. Exposure to absolute maximum rating conditions for extended periods of time may affect reliability.

**RECOMMENDED OPERATING CONDITIONS**

(0°C to 70°C)

PARAMETER	SYMBOL	MIN	TYP	MAX	UNITS	NOTES
TERMPWR Voltage	$V_{TP}$	4.00		5.25	V	
$\overline{PD}$ Active	$V_{PDA}$	-0.3		0.8	V	
$\overline{PD}$ Inactive	$V_{PDI}$	2.0		$V_{TP} + 0.3$	V	

**DC CHARACTERISTICS**

(0°C to 70°C)

PARAMETER	SYMBOL	MIN	TYP	MAX	UNITS	NOTES
TERMPWR Current	$I_{TP}$		5	250	mA	1,3
	$I_{TP}$			8	mA	1,4
Power Down Current	$I_{PD}$		100		$\mu$ A	1,2,5
Termination Resistance	$R_{TERM}$	108	110	112	ohms	1,2
Die Thermal Shutdown	$T_{SD}$		150		°C	1
Power Down Termination Capacitance	$C_{PD}$		8.5	10	pF	1,2,5,6
$\overline{PD}$ Hysteresis	$H_{PD}$		280		mV	1

**REGULATOR CHARACTERISTICS**

(0°C to 70°C)

PARAMETER	SYMBOL	MIN	TYP	MAX	UNITS	NOTES
Output Voltage	$V_{REF}$	2.79	2.85	2.91	V	1,2
Drop Out Voltage	$V_{DROP}$		0.75	1.0	V	3,6
Line Regulation	$L_{REG}$		1.0	2.0	%	1,4,6
Load Regulation	$L_{OREG}$		1.3	3.0	%	1,2,6
Current Limit	$I_{LIM}$	300	350	400	mA	1
Sink Current	$I_{SINK}$		200		mA	1

**NOTES:**

1. 4.00V < TERMPWR < 5.25V.
2. 0.0V < signal lines < 3.0V.
3. All signal lines = 0.0V.
4. All signal lines open.
5.  $\overline{PD}$  = 0.0V.
6. Guaranteed by design; not production tested.

**DS2107AS SCSI TERMINATOR 16-PIN SOIC (300 MIL)**

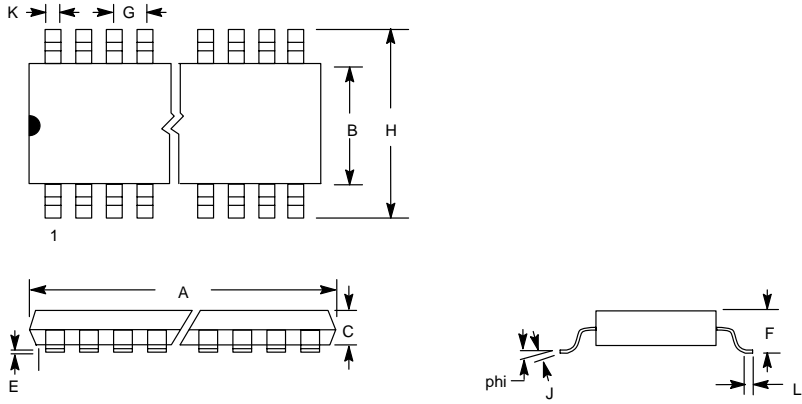

PKG	16-PIN	
DIM	MIN	MAX
A IN. MM	0.402 10.21	0.412 10.46
B IN. MM	0.290 7.37	0.300 7.65
C IN. MM	0.089 2.26	0.095 2.41
E IN. MM	0.004 0.102	0.012 0.30
F IN. MM	0.094 2.38	0.105 2.68
G IN. MM	0.050 BSC 1.27 BSC	
H IN. MM	0.398 10.11	0.416 10.57
J IN. MM	0.009 0.229	0.013 0.33
K IN. MM	0.013 0.33	0.019 0.48
L IN. MM	0.016 0.40	0.040 1.02
phi	0°	8°

**DS2107AE SCSI TERMINATOR 20-PIN TSSOP (PRELIMINARY)**

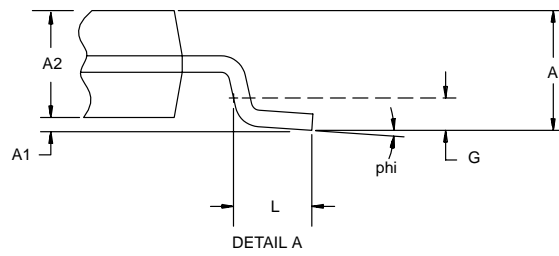
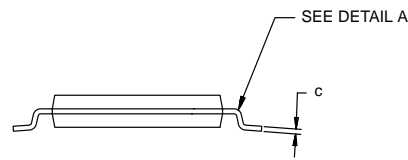
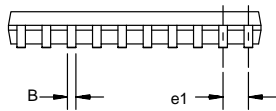
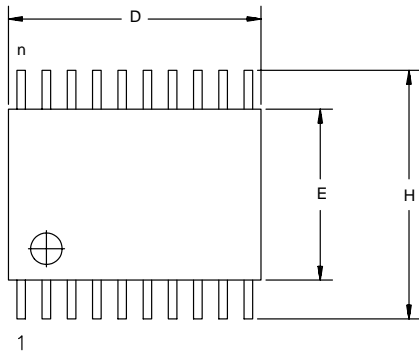

DIM	MIN	MAX
A MM	-	1.10
A1 MM	0.05	-
A2 MM	0.75	1.05
C MM	0.09	0.18
L MM	0.50	0.70
e1 MM	0.65 BSC	
B MM	0.18	0.30
D MM	6.40	6.90
E MM	4.40 NOM	
G MM	0.25 REF	
H MM	6.25	6.55
phi	0°	8°